

Ceiling LED Pendant

PD39317-UNV-010

INSTALLATION SHEET

START FROM HERE

- Make sure **POWER** is **COMPLETELY OFF** at the fuse box
- Have your fixture installed by a qualified licensed electrician
- Prepare everything in a clear area
- Wear gloves at all time during this installation
- Read instructions carefully before you start assembly
- Keep this installation sheet for future reference

Technical Support: 1-855-855-8926

Please Note:

- This Kuzco LED fixture comes with pre-wired LED module(s)
- Unless instructed, Do Not touch any part of the LED module(s) as any unnecessary contact with the module could cause permanent damage
- Use ELV (Electronic Low Voltage) or TRIAC or 0-10V type of dimmer for dimming application
- 120-277V input

1. Remove fixture from its original package
2. Separate mounting plate (1c) from canopy (2a) by removing canopy screws (2b) and separate non-power mounting plate (3c) from non-power canopy (5a) by removing screws (5b)
3. Attach mounting plate (1c) to electrical junction box (1a) using junction box screws provided (1e) in hardware package. Secure non-power mounting plate (3c) to non-power junction box (3a) with screws (3e)
4. Secure mounting plate (1c) to mounting surface with screws (1g) and anchors (1f)
5. Make proper electrical connections (black to hot "L", white to neutral "N", green to "GND", Dim + to purple, Dim- to gray) with wire nuts provided in hardware package
6. Attach canopy (2a) to mounting plate (1c) with canopy screws (2b). Secure non-power canopy (5a) to non-power mounting plate (3c) with screws (5b)

Wires	
Hot (Black)	_____
Neutral (White)	_____
Ground (Green)
Dim - (Gray): Optional	- - - - -
Dim + (Purple): Optional	- - - - -

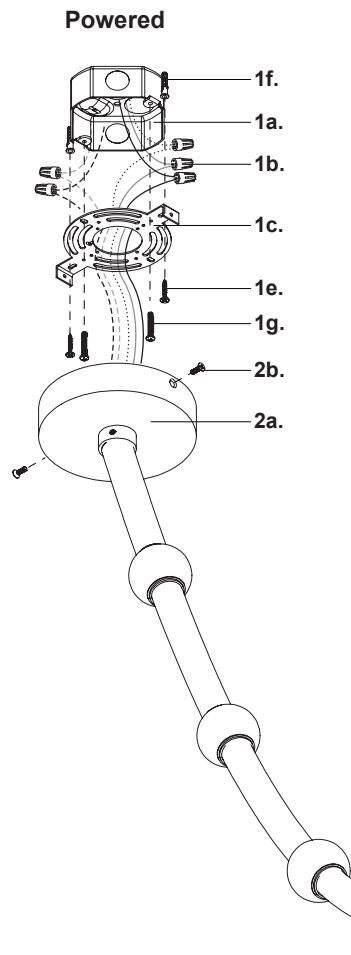

Non-Powered

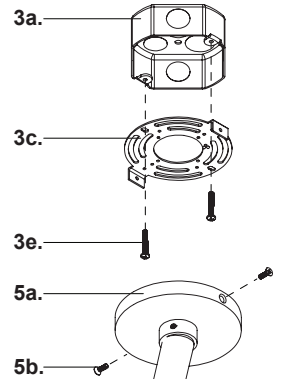

KUZCO

19054 28th Avenue Surrey, BC Canada V3Z 6M3
 T: 604 538 7162 TF: 1-855 85 KUZCO F: 604 538 7196
 W: kuzcolighting.com
 20250107